

# Inhalt

Seite

q_box	4
Die Abdeckplatten	5
Zubehör	6
Zubehör	7
Anwendungsbeispiele	8
push_box	9
push_box	10
Bestellvorlage	11

# q\_box

q\_box massive, gedämpfte Buche, geölt.

Fachböden massive, gedämpfte Buche, geölt. Glasfachböden auch für halbe q\_box Blankglas.

Fachböden werden mit Fachbodenträgern geliefert.

Stützleiste massive, gedämpfte Buche, geölt.

Halbe q\_box für 64 CDs.

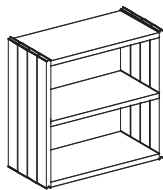
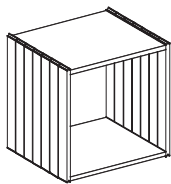

q_box		Halbe q_box für CDs mit Holzfachboden		mit Glasfachboden
B	36,7	36,7		36,7
H	37	37		37
T	32	18		18
Art.-Nr.	17001	17003		17004
Euro				

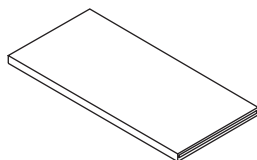
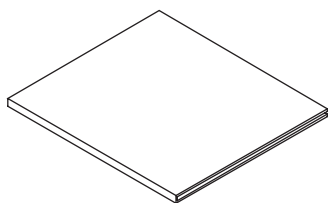

Fachböden für q_box			Fachböden für halbe q_box		
	Buche	Glas		Buche	Glas
B	33,5	33,4		33,5	33,5
H	13 mm	6 mm		13 mm	6 mm
T	30	30		16	16
Art.-Nr.	17010	17012		17011	17013
Euro					



Stützleiste	
B	42 mm
H	37,5
T	16 mm
Art.-Nr.	17009
Euro	

# Die Abdeckplatten

Abdeckplatten massiv Ahorn, geölt.

Sondermaße sind über Art.-Nr. 17099 zu bestellen

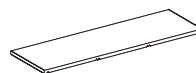

Abdeckplatte	1 Raster, 2 Fräsungen	2 Raster, 4 Fräsungen	3 Raster, 6 Fräsungen
B	40,7	77,4	114,1
H	22 mm	22 mm	22 mm
T	36	36	36
	17201	17202	17203
Euro			

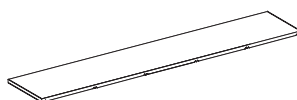
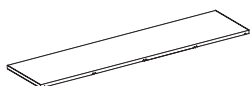

Abdeckplatte	4 Raster, 8 Fräsungen	5 Raster, 10 Fräsungen	Sondermaß
B	150,8	187,5	
H	22 mm	22 mm	22 mm
T	36	36	36
	17204	17205	17099
Euro			zzgl. Aufpreis pro Fräsung

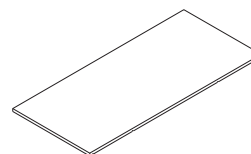
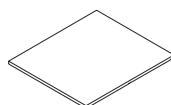

	Abdeckplatte Garderobe 2 Raster, 4 Fräsungen	Kindertischplatte 2 Raster, 4 Fräsungen	Schreibtischplatte 2 Raster, 4 Fräsungen
B	150,8	77,4	150,8
H	22 mm	22 mm	22 mm
T	36	68	68
	17209	17100	17105
Euro			

# Das Zubehör

## Hinweis:

In 1 Stück q\_box 17001  
passen 2 Einschubboxen nieder  
und 1 Fachboden Nr. 17010.

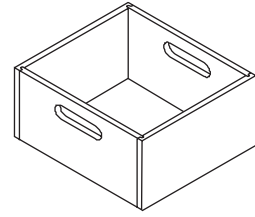
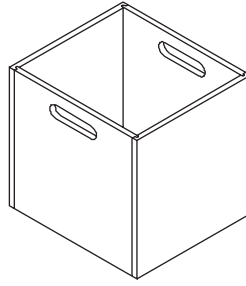
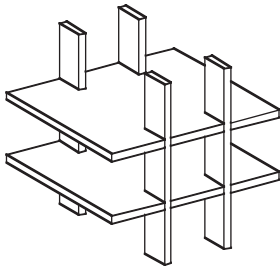

Weineinsatz für 9 Flaschen

Einschubbox hoch

Einschubbox nieder

B	33,2	33,0	33,0
H	33,2	31,0	15,5
T	30,0	29,5	29,5
Art.-Nr.	17020	17021	17022
Euro			

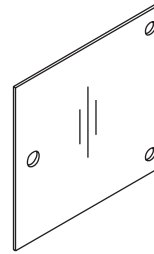
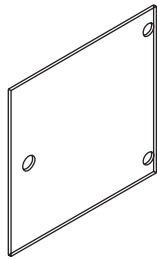

Glastür mit  
Topfbändern

Mattglas    Blankglas

Holzür mit  
Topfbändern

Buche    Ahorn    Nussbaum

B	35,9	35,9	35,9	35,9	35,9
H	6 mm	6 mm	6 mm	6 mm	6 mm
T	35,5	35,5	35,5	35,5	35,5
Art.-Nr.	17025	17026	17027	17028	17029
Euro					

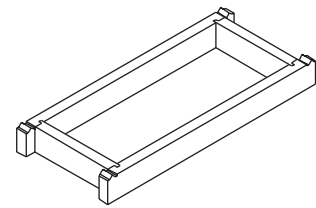
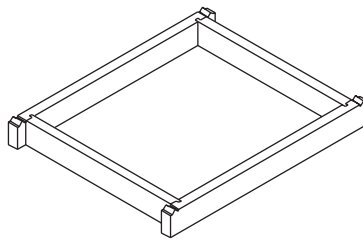
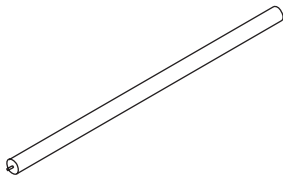

Garderobenstange mit 2 Stahlstiften

Sockel für qbox

Sockel für halbe qbox

B	73,4	36,7	36,7
H	D 32 mm	43 mm	43 mm
T		30,0	16,0
Art.-Nr.	17200	17210	17211
Euro			

Kissenauflage

Stoffbezug

Lederbezug

B	113	113
H	4	4
T	32	32
Art.-Nr.	17300	17301
Euro		

# Das Zubehör

## Garderobenset "A" für 1 Stück q\_box

bestehend aus:

1 Stange Edelstahl L 600 mm;  $\varnothing$  16 mm

Endkappen aus Edelstahl

2 Haken zur Befestigung der Stange an der q\_box.

1 Sperrholz-Befestigungsplatte für Wandmontage.

Dient auch als Bohrschablone für Bohrungen durch die Rückwand.

Art.-Nr.

17212

Euro

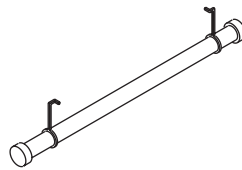
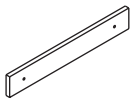

## Garderobenset "B" für 2 Stück q\_box

bestehend aus:

1 Stange Edelstahl L 1200 mm;  $\varnothing$  16 mm

Endkappen aus Edelstahl

2 Haken zur Befestigung der Stange an der q\_box.

2 Sperrholz-Befestigungsplatte für Wandmontage.

Dient auch als Bohrschablone für Bohrungen durch die Rückwand.

Art.-Nr.

17213

Euro

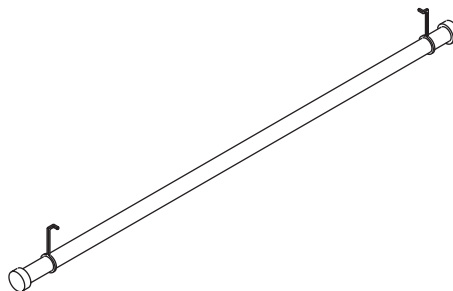
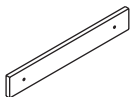

# Anwendungsbeispiele

2 q\_boxen

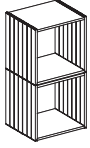

3 q\_boxen

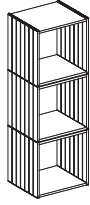

3 q\_boxen

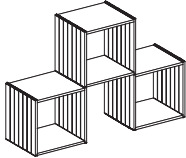

6 q\_boxen

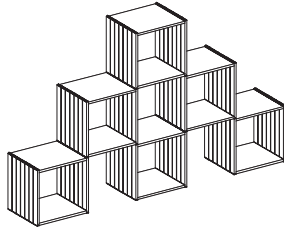

9 q\_boxen, 4 Stützleisten

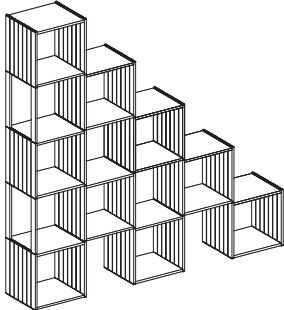

6 q\_boxen, 4 Stützleisten

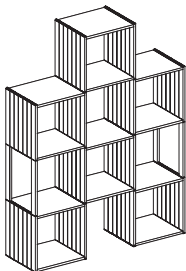

9 q\_boxen, 8 Stützleisten

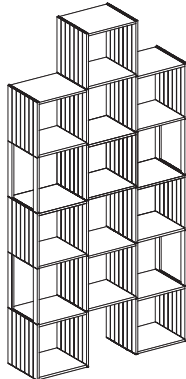

13 q\_boxen, 8 Stützleisten

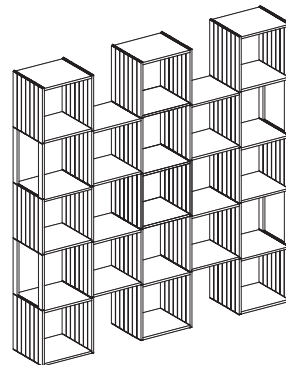

# push\_box

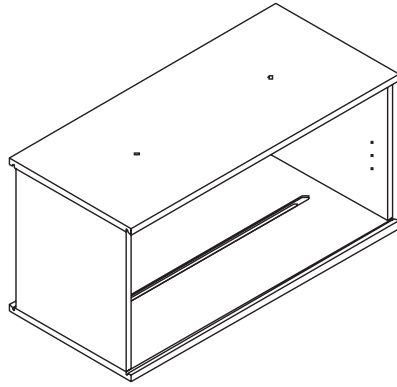

## push\_box

B 74,4

H 37,2

T 37,2

Art. Nr. 18001

Euro

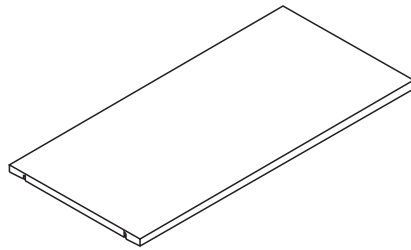

## Fachboden für push\_box

B 71,1

H 1,6

T 33,6

Art.-Nr. 18010

Euro

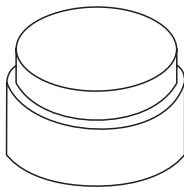

## Satz Gestellfüße

Art.-Nr. 18030

Euro

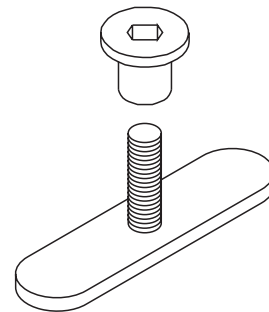

## Verbindungsbeschlag/Edelstahl

18040

# push\_box

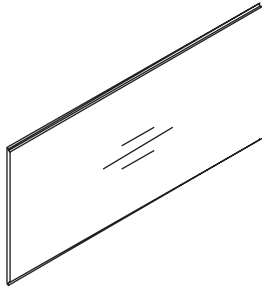

Front und Rückwand

B	74,4	B	74,4	B	74,4
H	0,9	H	0,9	H	0,9
T	34,8	T	34,8	T	34,8
Art.-Nr.	18020 Buche		18021 Ahorn		18022 Nußbaum
Euro					

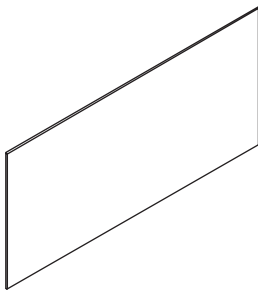

Front und Rückwand









B	74,4	B	74,4
H	0,4	H	0,4
T	34,8	T	34,8
Art.-Nr.	18023 Klarglas		18024 Mattglas
Euro			

# Kopiervorlage für Ihre Bestellungen

**wasa wohnen GmbH & Co. KG**  
In der Schorbach 1  
D-67714 Waldfischbach-Burgalben  
Tel. +49 6333 275 - 0  
Fax +49 6333 275 - 175  
post@wasamoebel.de

Hiermit bestellen wir verbindlich die unten aufgeführten Artikel:

**Palette A**                      Stückzahl.....  
bestehend aus:

Pos 1	<b>q_box</b>	42 Stk.	
Pos 2	halbe <b>q_box</b> für CD	5 Stk.	
Pos 3	Sockel / <b>q_box</b>	6 Stk.	
Pos 4	Fachboden / <b>q_box</b>	4 Stk.	
Pos 5	Weineinsatz für 9 Flaschen	2 Stk.	
Pos 6	Stützleisten	12 Stk.	
Pos 7	Einschubbox hoch	2 Stk.	
Pos 8	Einschubbox nieder	2 Stk.	
Pos 9	Mattglastür inkl. Beschlägen und Bohrschablone	2 Stk.	

**Palette B**                      Stückzahl.....  
bestehend aus:

Pos 1	<b>q_box</b>	45 Stk.	
-------	--------------	---------	---

zusätzliche Bestellinformationen:

.....

.....

.....

.....

.....

Stempel:	Datum:	Unterschrift:
----------	--------	---------------